

# MINI DOOR SERIES 650

## General Description

- The 650 is the premium door for easy operation and maintenance
- The door features shielded steel radial bearings on both support brackets
- The DBCi tension bracket allows you to easily, quickly, and safely adjust tension on your door
- With unlimited tensioning positions, the 650 door can be adjusted to just the right amount of tension and avoid costly service calls
- **Rain lip note:** For proper exterior door installation, a 1 1/2" deep rain lip must be formed in the concrete slab, extending a minimum of 3 1/2" from the interior face of the jamb.

## Curtain

- 26-gauge grade E hard steel, 5/8" deep ribbed corrugation
- 20 standard colors – special colors upon request
- Wash coat over primer interior side
- The WeatherX system is recognized for its remarkable color and gloss retention as well as its superior chalk resistance
- The WeatherX system allows the product to endure the physical abuses of fabrication, transit and construction while minimizing cracking
- 25-year film integrity warranty – up to 25-year chalk and fade
- Stainless steel latch. 2 padlock style, cylinder style, or with the new cast zinc Apex latch. All latches accept double locks and 7/16" shackles.



## Bottom Bar

- 6063-T6 aluminum extrusion
- 1 1/2" x 1 1/2" galvanized angles to provide structural stability, security, and increase windloads
- Bulb astrical – replaceable vinyl weather seal



## Axle Assembly

- 1 5/16" O.D. steel axle 14-gauge
- Oil tempered torsion springs
- 18-gauge 9.5" drums
- Fully accessible springs for inspection



Opening sized thru 10' x 10'

## INTERIOR ELEVATION

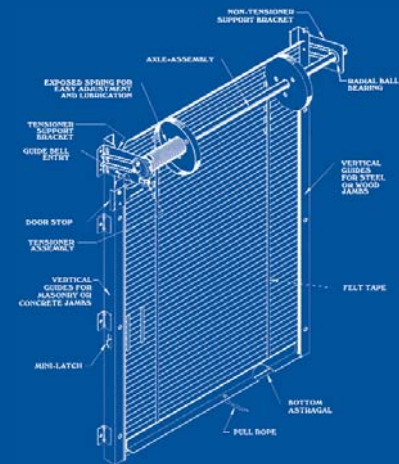

## GUIDE MOUNTING

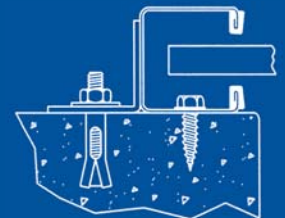

Masonry Mount

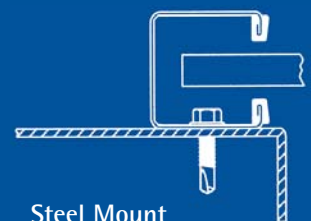

Steel Mount

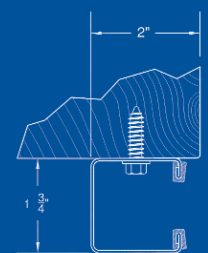

WOOD JAMBS

Wood Mount

The Power of INNOVATION.



The Strength of PARTNERSHIP.

## GUIDE DETAIL

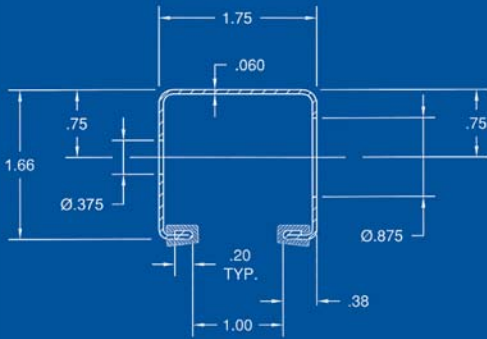

## DOOR ENGAGEMENT

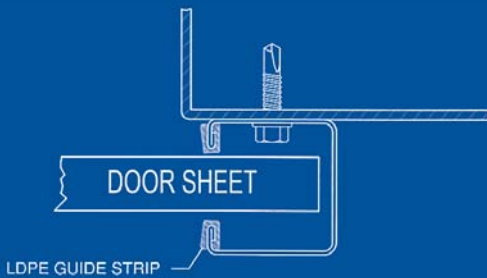

## INSULATED DOOR DETAIL

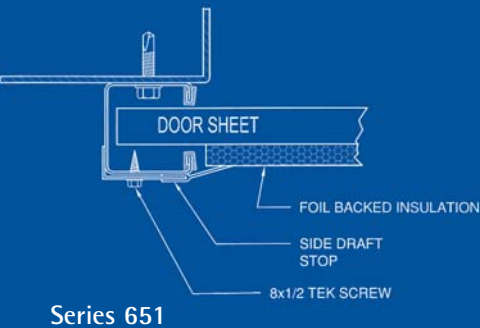

## Guides

- 18-gauge galvanized steel guides
- Pre-punched holes for anchors, slide latch, and bracket attachment
- Polyethylene guide strips provide easy, quiet operation
- Pre-punched holes for head stop attachment



## Hardware

- 12-gauge head stops have slotted mounting holes for proper attachment
- 14-gauge galvanized steel handles
- 12-gauge tension bracket is coiled for additional strength. Shielded radial bearings for smooth operation. Worm gear adjusting design allows unlimited adjusting positions.
- 12-gauge bearing bracket left side



## Options

- Insulation (Series 651)
- Top and side draft stop
- Comes standard in our new easy to use tension bracket

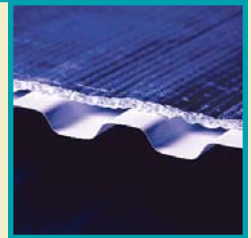

## DBCi's Self-storage Solutions Include:

### Self-storage Doors

- 650 series
- Wind load doors
- Insulated doors

### Hallway Systems

- System 500 swing door (Flush and corrugated)
- System 300 swing door (Flush and corrugated)
- Header
- Filler panel
- Corawall
- Securawall

### Soffit Systems

- Hall soffit (three-piece)
- Light soffit
- Entry soffit
- Flush ceiling

### Security Solutions

- Mesh security wire
- Burglar security bars

### Safeguards

- Kickplate
- Cornerguards
- Linerwall

\*CONTACT A DBCi SALES REPRESENTATIVE FOR A DETAILED DRAWING.



DBCi • DOORS AND BUILDING COMPONENTS, LLC.

\* Austin Building Systems, Inc., [www.buildmetal.com](http://www.buildmetal.com)